

PUŠKU PUŠKU

Create happiness



PRODUCTS constantly expanding variety
of models and fabrics

SERVICES additional services provided as
print and embroidery

EXCLUSIVE OFFERS customization of products
and creation of unique models



Puśku puśku

The biggest bean bag manufacturer in Northern Europe

Agent France: Agence DESIGNENVUE

Phone nr.: +33 688 567 728

Email: info@designenvue.com

Contacts

www.puskupusku.com | Email: info@puskupusku.com

Phone nr.: +370 685 50921

We sell and ship bean bags world wide!

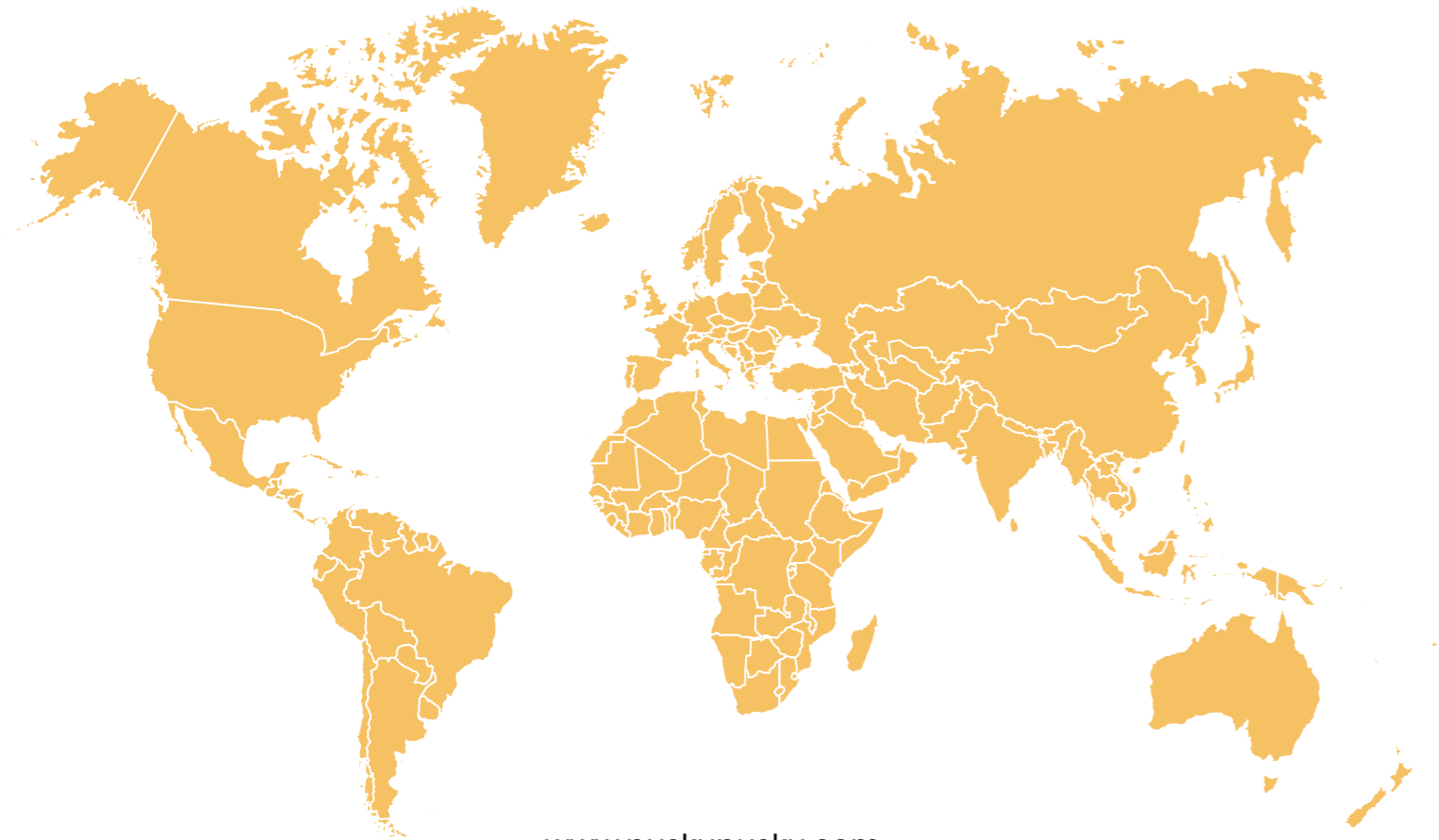

www.puskupusku.com

Hello!

We are a young and creative team at the enterprise Ltd Pupt, which has maintained the *Pusku pusku* brand in Lithuania and abroad **since 2008**. We follow a philosophy that people do not need big changes or investments in their lives to be happy.

Those joyful moments when you fall into a bean bag and dream a bit or share your thoughts and stories about the day with your loved ones, are natural forms of happiness in which we can all participate. Inspired by this view, we offer a choice of **more than 1500** different bean bags created for modern people who seek new designs and uniqueness in every detail. With a wide range of colours, fabrics and models, even the pickiest person can find a product just for her or him.

We at *Pusku pusku* are pleased to be **the biggest bean bag manufacturer** in Northern Europe, and we are also becoming known all over the world! We are proud that there is special attention for our products in Germany, Italy, Netherlands, Sweden, Finland, Estonia, Latvia, which is why we export more than 60 % of them.

Printed and embroidered bean bags can be even more extraordinary with the unique image or logo of a client. We try to ensure pleasant customer service and guarantee high-quality products, because **we love what we do!** We discover new ideas every day and constantly search for new opportunities, so we're open to all ideas and suggestions.

Young and creative: that's us. Let's meet each other!

The Pusku pusku team

PUŠKU PUŠKU

Create happiness

AVAILABLE MODELS

NEW FOAM BEAN BAG MODELS



ON 60

New relax experience!
Dimensions: Length: 60 cm,
Height: 35 cm, Width: 60 cm,
Weight: 4 kg



OM 85

New relax experience!
Dimensions: Length: 85 cm,
Height: 60 cm, Width: 85 cm,
Weight: 9 kg



OM 110

New relax experience!
Dimensions: Length: 110 cm,
Height: 75 cm, Width: 110 cm,
Weight: 16 kg



OM 135

New relax experience!
Dimensions: Length: 135 cm,
Height: 90 cm, Width: 135 cm,
Weight: 27 kg



MINI

For unexpected guests!
Dimensions: Length: 45 cm,
Height: 35 cm, Width: 45 cm,
Volume: 50 L



UP!

For kids and guests!
Dimensions: Length: 45 cm,
Height: 40 cm, Width: 45 cm,
Volume: 85 L



PLUS

For tired legs!
Dimensions: Length: 80 cm,
Height: 50 cm, Width: 60 cm,
Volume: 180 L



SOFTBOX

For everyday comfort!
Dimensions: Length: 65 cm,
Height: 40 cm, Width: 65 cm,
Volume: 170 L



ROLL 85

For extra soft lounging!
Dimensions: Length: 88 cm,
Height: 60 cm, Width: 88 cm,
Volume: 300 L



GAME

For happy kids!
Dimensions: Length: 75 cm,
Height: 65 cm, Width: 75 cm,
Volume: 200 L



RAZZY

For active kids!
Dimensions: Length: 110 cm,
Height: 65 cm, Width: 70 cm,
Volume: 150 L



SEAT

For everyone's comfort!
Dimensions: Length: 100 cm,
Height: 85 cm, Width: 80 cm,
Volume: 400 L



TUBE

Lithuanian passion,
Italian design!
Dimensions: Length: 120 cm,
Height: 80 cm, Width: 73 cm,
Volume: 370 L



SOFT TABLE 60

For sitting and setting!
Dimensions: Length: 65 cm,
Height: 40 cm, Width: 65 cm,
Volume: 170 L



ROLL 100

For extra soft lounging!
Dimensions: Length: 100 cm,
Height: 65 cm, Width: 100 cm,
Volume: 400 L



COCOON

A child's best friend!
Dimensions available:
Length: 80 cm, 100 cm, 120 cm
Height: 50 cm, 60 cm, 65 cm
Width: 45 cm, 55cm 60 cm
Volume: 100 l, 170 l, 290 l



RAZZ

For extraordinary comfort!
Dimensions: Length: 125 cm,
Height: 90 cm, Width: 110 cm,
Volume: 340 L



LOUNGE

For a relaxing evening!
Dimensions: Length: 130 cm,
Height: 80 cm, Width: 80 cm,
Volume: 430 L



TUBE XL

For special rest!
Dimensions: Length: 120 cm,
Height: 80 cm, Width: 100 cm,
Volume: 560 L



MOOG

For royal rest!
Dimensions: Length: 95 cm,
Height: 65 cm, Width: 125 cm,
Volume: 730 L



SOFA SEAT

For a cozy get-together
with friends!
Dimensions: Length: 100 cm,
Height: 85 cm, Width: 150 cm,
Volume: 820 L



PLAY

For both, the big and
the little ones!
Dimensions: Length: 80 cm,
Height: 85 cm, Width: 80 cm,
Volume: 250 L



RAZZMATAZZ

For spacious home!
Dimensions: Length: 160 cm,
Height: 95 cm, Width: 120 cm,
Volume: 500 L



SUNBED

For comfortable lying!
Dimensions available:
Length: 180 cm, Height: 80 cm
Widths: 70 cm, 100 cm, 140 cm
Volumes: 600 l, 700 l, 1000 l



SOFA TUBE

An Italian design sofa for two!
Dimensions available:
Length: 120 cm, 105 cm
Height: 80 cm
Width: 135 cm, 160 cm, 190cm
Volume: 800 L, 1000 L, 1200L



SOFA MOOG

For royal rest in couples!
Dimensions: Length: 100 cm,
Height: 65 cm, Width: 195 cm,
Volume: 1060 L



SOFA LOUNGE

For relaxation in couples!
Dimensions: Length: 130 cm,
Height: 85 cm, Width: 150 cm,
Volume: 1000 L

AVAILABLE FABRIC AND COLOURS

Waves - wide wale corduroy!



Gaia - recycled from used PET bottles



Murrr - soft and fluffy faux fur!



Teddy - luxurious and very fashionable!



Lure Luxe - charming and stylish velour



Capri - the Italian spirit in your terrace!



Canaria - like a holiday in Spain!



Colorin - a practical choice for the summer!



Masterful - luxurious and high quality!



Outside - inside and outside!



Nordic - stylish and Scandinavian!



Home - cozy and subtle!



Riviera - for temporary use in the open air!



Sideway - inspired by nature!



Barcelona - modern and luxurious!



Lure Floral - charming and stylish velour



OX - youthful and flamboyant!



All our bean bags are hand crafted in Lithuania with precision to every detail.



BEAN BAG GUIDE

FIND YOUR OWN BEAN BAG



ON 60

Put your feet on!

designed by
balciuno

Pusku pusku Catalogue

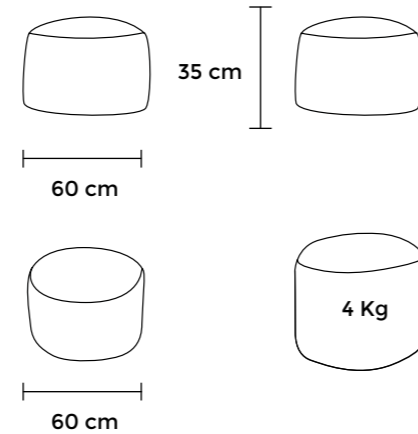

Foam bean bag

-  Length: **60 cm**
-  Height: **35 cm**
-  Width: **60 cm**
-  Weight: **4 Kg**
-  Handmade
-  With inner bag

On 60 - a comfortable and very soft pouf designed to stretch your tired legs conveniently. The handmade foam pouf is compact in size, so it takes up little space at home; it is easy to move to different places in the room. *On 60* foam pouf is the best combination of comfort and relaxation with foam bean bags - *Om*. Bean bags are filled with highest quality foam flakes.

Designed by *balciuno*



// MODEL & FABRIC: ON 60 TEDDY

OM 85

Fall into. Burst into. Melt into

designed by
balciuno

Pusku pusku Catalogue

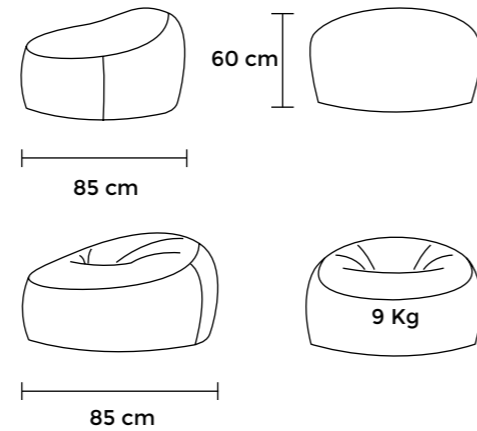

Foam bean bag

-  Length: **85 cm**
-  Height: **60 cm**
-  Width: **85 cm**
-  Weight: **9 Kg**
-  Handmade
-  With inner bag

Om 85 – comfortable and super soft the smallest size foam bean bag is the best fit for small children and teenagers. These foam bean bags are the perfect addition to any nursery, playroom, child's bedroom. Matching pillows are available and recommended for ultimate comfort. Comfortable addition recommended: *On* - specially designed to put comfortably your feet on!

Designed by *balciuno*



// MODEL & FABRIC: OM 85 WAVES, PILLOW SQUARE 65 WAVES

OM 110

Fall into. Burst into. Melt into

designed by
balciuno

Pusku pusku Catalogue

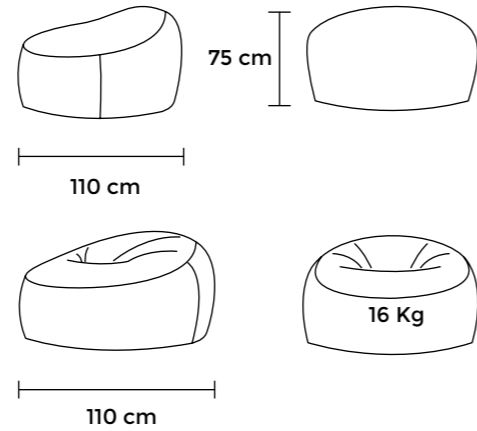

Foam bean bag

-  Length: **110 cm**
-  Height: **75 cm**
-  Width: **110 cm**
-  Weight: **16 Kg**
-  Handmade
-  With inner bag

Om 110 - This is a whole new relax experience, truly luxury softness and comfort. You will enjoy super thought over models for ultimate your body relax. And we are pretty sure that you will have a hard time leaving this super comfortably designed soft and satisfying bean bag. *Om 110* - comfortable 1 person relax, soft medium sized foam bean bags are the perfect addition to any nursery, playroom, child's bedroom. With a variety of beautiful colors and textures to choose from, these luxury items make a comfortable accent for any room. Comfortable addition recommended: *On* - specially designed to put comfortably your feet on!

Designed by *balciuno*



// MODEL & FABRIC: OM 110 TEDDY, PILLOW SQUARE 65 TEDDY

OM 135



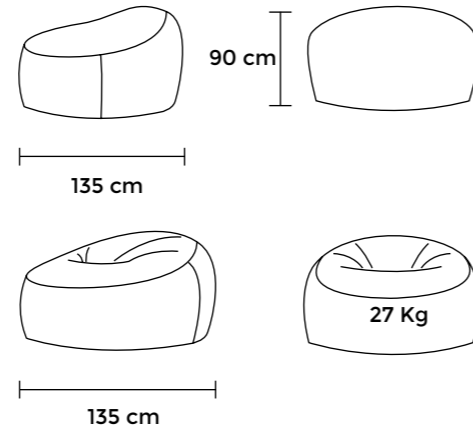

Fall into. Burst into. Melt into

designed by
balciuno

Pusku pusku Catalogue



Foam bean bag

-  Length: **135 cm**
-  Height: **90 cm**
-  Width: **135 cm**
-  Volume: **27 Kg**
-  Handmade
-  With inner bag

Om 135 - This is a whole new relax experience, truly luxury softness and comfort. You will enjoy super thought over models for ultimate your body relax. And we are pretty sure that you will have a hard time leaving this super comfortably designed soft and satisfying bean bag. *Om 135* - super comfy big size for 1 person, it can easily support 2 toddlers, 2 kids. Bigger in size *Om* model 135 diameter are perfect addition for spacious living rooms, open office spaces, reading corners, teen bedrooms and student rooms. With a variety of beautiful colors and textures to choose from, these luxury items make a comfortable accent for any room. Comfortable addition recommended: *On* - specially designed to put comfortably your feet on!

Designed by *balciuno*



// MODEL & FABRIC: OM 135 GAIA, PILLOW SQUARE 65 GAIA

Pillows Square 55&65

Complete your interior with stylish accents!

Pusku pusku Catalogue



Pillow Square 55

Length: 55 cm

Height: 40 cm

Pillow Square 65

Length: 65 cm

Height: 45 cm

Handmade

Let us introduce you to our beautiful collection of throw pillows matching all of our bean bags - *Pillow Square*. Pillows are great interior details and the easiest and fastest way to improve any interior, add up some spice or comfort. You can have as many as you want pillows on your sofas, bean bags. Pillow can become a uniting bridge in your interior between new and old furniture pieces. Example you bring some green bean bag home, so that this furniture does not feel alone, add up some decorative pillows same color and texture, and you will get the balanced view.

Pillows Square are washable, and light so you can carry them around your house. Change cover, change color and make them outdoor instead of indoor. Multi-functional comfort and pretty wherever you are.



// MODEL & FABRIC: OM 135 GAIA, PILLOW SQUARE 65 GAIA

TUBE
FAMILY







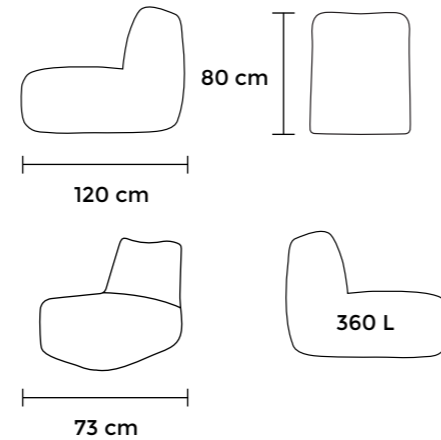

Tube

Lithuanian passion, Italian design!

DESIGNED IN ITALY
BY
whynot

Pusku pusku Catalogue



-  Length: **120 cm**
-  Height: **80 cm**
-  Width: **73 cm**
-  Volume: **360 L**
-  Handmade
-  With inner bag

The *Tube* model was created by Italian product designer Francesco Costacurta and is made and assembled by Pusku pusku in Lithuania. *Tube* is elliptically tubular bean bag, which is the best alternative to usual chair. Tube model is one of our best sellers. It offers very comfortable and stable sitting experience. The special construction of the internal bag lets it maintain a stable bean bag shape and the comfortable backrest ensures comfort and relaxation. A bean bag is handmade and fabric cut diagonally and joined, thus creating a stylish geometric composition.



// MODEL & FABRIC: TUBE LURE FLORAL, MINI WAVES

Tube 100

For extraordinary relaxation!

DESIGNED IN ITALY
BY
whynot

Pusku pusku Catalogue

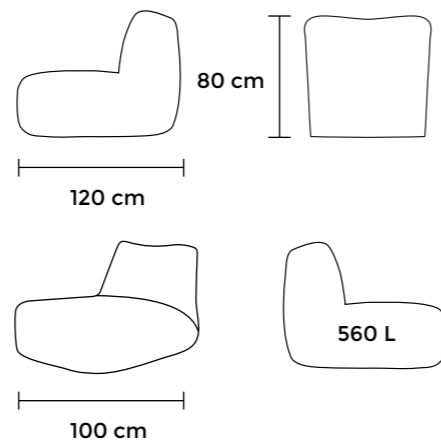

-  Length: **120 cm**
-  Height: **80 cm**
-  Width: **100 cm**
-  Volume: **560 L**
-  Handmade
-  With inner bag

The *Tube 100* model was created by Italian product designer Francesco Costacurta and is made and assembled by Pusku pusku in Lithuania. One or two people can rest comfortably on this hand-made bean bag, making it quite universal. It's suitable for terraces, living rooms or offices. The special construction of the internal bag lets it maintain a stable armchair shape and the comfortable backrest ensures comfort and relaxation. *Tube 100* is the best choice for anyone searching for a comfortable, unique and exceptional piece of furniture for a great rest.



// MODEL & FABRIC: TUBE 100 LURE FLORAL





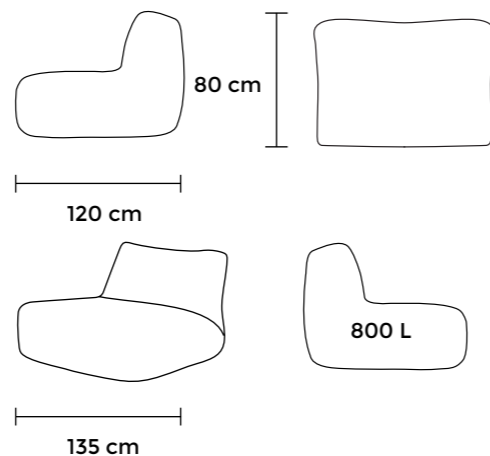

Sofa Tube

An Italian-designed sofa for two!

DESIGNED IN ITALY
BY
whynot

Pusku pusku Catalogue



-  Length: **120 cm**
-  Height: **80 cm**
-  Width: **135 cm**
-  Volume: **800 L**
-  Handmade
-  With inner bag

Sofa Tube is an Italian-designed sofa made for two people to rest comfortably. This bean bag model was created by an Italian product designer named Francesco Costacurta who represents a company called Why Not in Milan. This hand-made furniture is made with a comfortable backrest to lean against. The new inner bag technology ensures an especially comfortable rest that several family members will be able to enjoy simultaneously. This sofa can easily be carried over into another room, so this bean bag will become your favourite oasis of rest. *Sofa Tube* is a great choice for those looking for an alternative to ordinary sofas and a unique design solution for their home.



// MODEL & FABRIC: SOFA TUBE LURE FLORAL, MINI BARCELONA

Sofa Tube 160

Lithuanian passion, Italian design!

DESIGNED IN ITALY
BY
whynot

Pusku pusku Catalogue

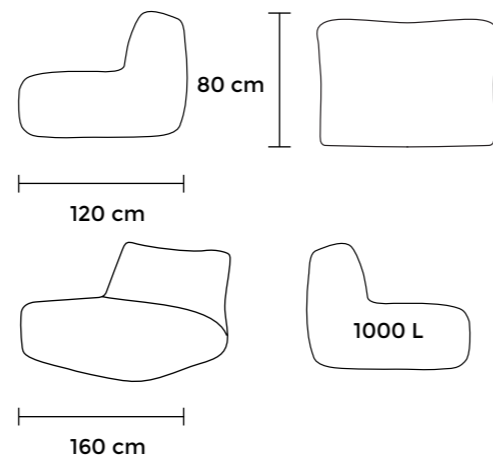

-  Length: **120 cm**
-  Height: **80 cm**
-  Width: **160 cm**
-  Volume: **1000 L**
-  Handmade
-  With inner bag

Sofa Tube 160 is a great choice for those who are looking for an alternative to ordinary sofas and unique design solution for their home. The special construction of the internal bag lets it maintain a stable shape and the comfortable backrest ensures comfort and relaxation. Two people can rest comfortably on this hand-made beanbag, making it quite universal. It's suitable for terraces, living rooms or other spaces of rest. Sofa can easily be carried over into another room, so this bean bag will become your favorite oasis of rest wherever you want to be.

This bean bag model was created by an Italian product designer named Francesco Costacurta who represents a company called Why Not in Milan.



// MODEL & FABRIC: SOFA TUBE 160 LURE FLORAL

Sofa Tube 190

Lithuanian passion, Italian design!

DESIGNED IN ITALY
BY
whynot

Pusku pusku Catalogue

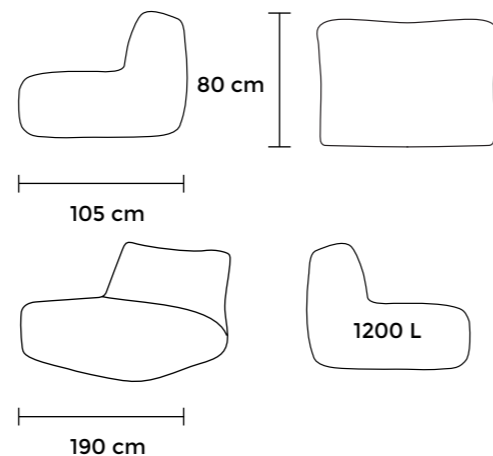

-  Length: **105 cm**
-  Height: **80 cm**
-  Width: **190 cm**
-  Volume: **1200 L**
-  Handmade
-  With inner bag

Sofa Tube 190 is our ultimate model alternative for those who are looking for a royal comfort and / or are willing to replace their regular sofa. Also it is a great option to fill in big spaces with a comfortable, big, soft piece of furniture that is tempting to lie down on from the very first sight. Needless to mention that with a wide range of various fabrics we offer it becomes one of the most stylish things in the house.

Hand-made furniture is made with a comfortable backrest to lean against. The inner bag technology ensures an especially comfortable rest that several people will be able to enjoy simultaneously.

This bean bag model was created by an Italian product designer named Francesco Costacurta who represents a company called Why Not in Milan.



// MODEL & FABRIC: SOFA TUBE 190 BARCELONA, MINI LURE FLORAL

SEAT

FAMILY



Seat



For everyone's comfort!

designed by
balciuno

Registered design

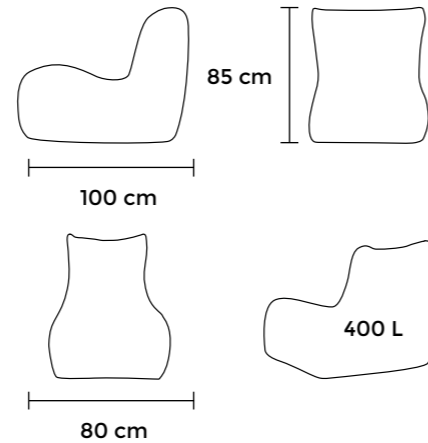
Pusku pusku Catalogue



-  Length: **100 cm**
-  Height: **85 cm**
-  Width: **80 cm**
-  Volume: **400 L**
-  Handmade
-  With inner bag

Seat is an armchair-shaped bean bag that has already become classic and has had its model design patented. Handmade bean bag is designed with a comfortable backrest and headrest; the granules inside it adapt to the body shape, so a person can have a pleasant relaxation. This soft piece of furniture is designed for different needs: it is convenient when you work or play computer games, watch movies, read books. *Seat* is a universal bean bag, and therefore, suitable for the use in homes, cottages, conference rooms and events.

Designed by *balciuno*



// MODEL & FABRIC: SEAT CANARIA, SOFTBOX CANARIA





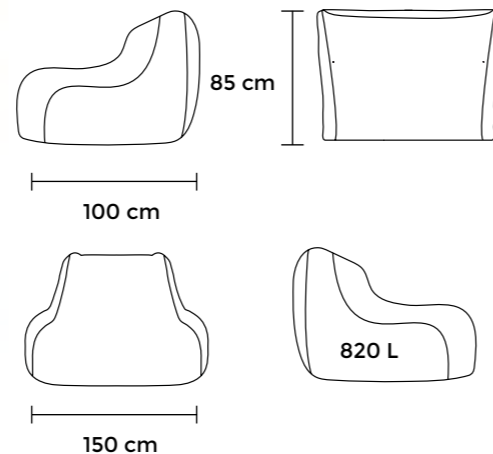

Sofa Seat

For a cozy get-together with friends!

designed by
balciuno

Pusku pusku Catalogue



-  Length: **100 cm**
-  Height: **85 cm**
-  Width: **150 cm**
-  Volume: **820 L**
-  Handmade
-  With inner bag

Sofa Seat is a comfortable bean bag, which is the best alternative to conventional sofas. The model of handmade bean bag reminds a standard sofa, but as soon as you sit down, the granules adapt to the shape of your body, and it becomes even more comfortable; it is easy to move and go through any door. Several friends and family members can enjoy this bean bag at the same time. *Sofa Seat* is a universal sofa that is suitable for not only watching TV, but also cosy sitting by the fireplace, reading and working at the computer.

Designed by *balciuno*



// MODEL & FABRIC: SOFA SEAT SIDEWAY, MINI SIDEWAY





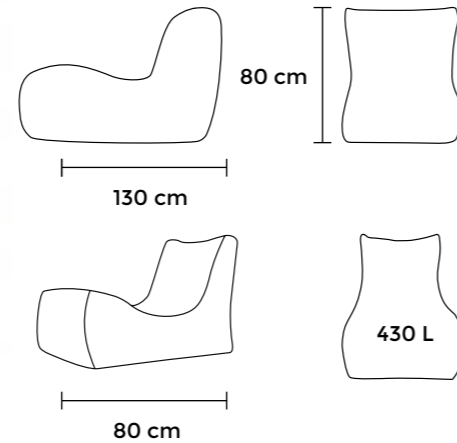

Lounge

For a relaxing evening!

designed by
balciuno

Pusku pusku Catalogue



-  Length: **130 cm**
-  Height: **80 cm**
-  Width: **80 cm**
-  Volume: **430 L**
-  Handmade
-  With inner bag

Lounge is an armchair-shaped bean bag designed for comfortable relaxation. Handmade bean bag has a backrest and extended sitting part, so a person can pleasantly support his back and head and stretch his tired legs. *Lounge* is a soft armchair, which is often used in rest rooms of companies or home terraces, courtyards and homesteads.

Designed by *balciuno*



// MODEL & FABRIC: LOUNGE CANARIA

Sofa Lounge

Relaxation for couples!

designed by
balciuno

Pusku pusku Catalogue

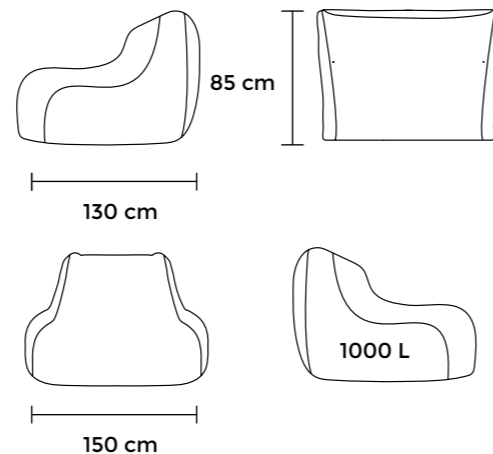

-  Length: **130 cm**
-  Height: **85 cm**
-  Width: **150 cm**
-  Volume: **1000 L**
-  Handmade
-  With inner bag

Sofa Lounge is a sofa-shaped bean bag for pleasant relaxation for two. A handmade soft piece of furniture is designed with a backrest and extended sitting part, so it is easy to rest on it and stretch your legs. This bean bag adapts to the body shape of a person; external slipcover can be taken off and cleaned up, and therefore, it is a great alternative to standard sofas. *Sofa Lounge* is a perfect choice for those, who have much space in their houses, homesteads and offices.

Designed by *balciuno*



// MODEL & FABRIC: SOFA LOUNGE CAPRI, SOFTBOX CAPRI

Sunbed

For lazing around!

designed by
balciuno

Pusku pusku Catalogue

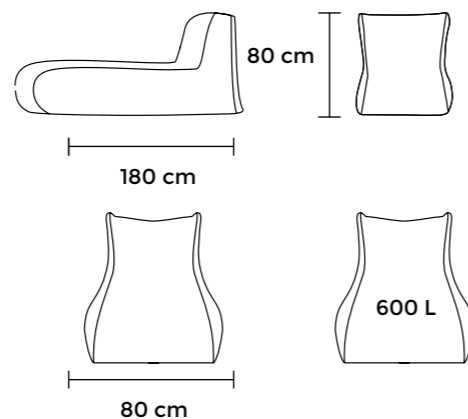

-  Length: **180 cm**
-  Height: **80 cm**
-  Width: **80 cm**
-  Volume: **600 L**
-  Handmade
-  With inner bag

Sunbed is a deckchair-shaped bean bag for lovers of lying by the pool or on the terrace. Almost two meters long handmade bean bag is perfect for tall people and lovers of sunbathing. This bed is designed with a comfortable backrest; the granules inside it adapt to the body shape, so a person can have a pleasant relaxation. *Sunbed* is a comfortable bean bag, which is often used on terraces of restaurants, cottages and hotel spaces by water pools.

Designed by *balciuno*



// MODEL & FABRIC: SUNBED COLORIN, SUNBED CAPRI, SOFT TABLE 60 CAPRI



Sunbed 90

Lounging in the sun comfortably!

designed by
balciuno

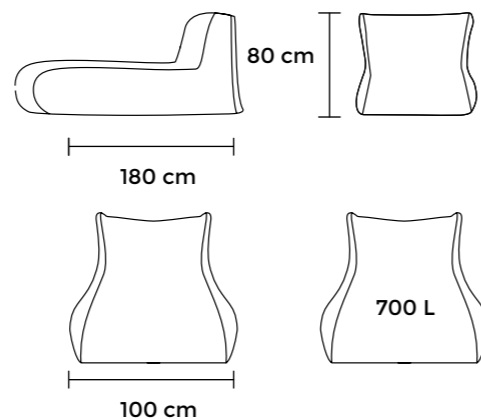
Pusku pusku Catalogue



-  Length: **180 cm**
-  Height: **80 cm**
-  Width: **100 cm**
-  Volume: **700 L**
-  Handmade
-  With inner bag

Sunbed 90 is a deckchair-shaped bean bag for lovers of lying by the pool or on the terrace. Almost two meters long handmade bean bag is perfect for tall people and lovers of sunbathing. This bean bag is designed with a comfortable backrest; the granules inside it adapt to the body shape, so a person can have a pleasant relaxation. *Sunbed 90* is a comfortable bean bag, which is often used on terraces of restaurants, cottages and hotel spaces by water pools.

Designed by *balciuno*



// MODEL & FABRIC: SUNBED 90 CAPRI

Sofa Sunbed

For royal relaxation by the sun

designed by
balciuno

Pusku pusku Catalogue

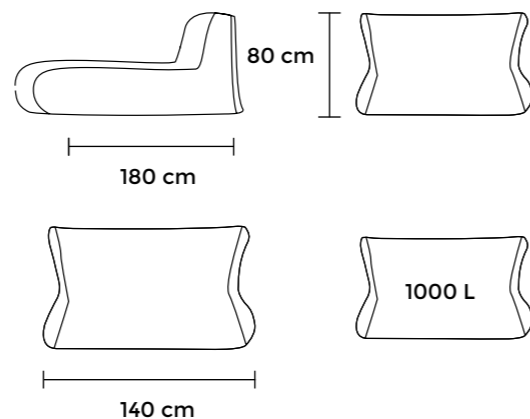

- Length: **180 cm**
- Height: **80 cm**
- Width: **140 cm**
- Volume: **1000 L**
- Handmade
- With inner bag

Sofa Sunbed - designed for royal rest and perfect comfort. This deckchair-shaped bean bag made for lovers of lying by the pool or on the terrace, where you can just relax while reading your favorite book or drinking your favorite lemonade. On this bean bag can lie more than one people, it is 140 cm wide and 1,8 meters long. *Sofa Sunbed* is made with a comfortable backrest, the granules inside it adapt to the body shape, so a person can have a pleasant relaxation. *Sofa Sunbed* is a comfortable bean bag, which is often used on terraces of restaurants, cottages and hotel spaces by water pools.

Designed by *balciuno*



// MODEL & FABRIC: SOFA SUNBED CAPRI

Large beach towel

For royal relaxation!

Pusku pusku Catalogue



Available in 3 sizes.

For model Sunbed:
230cm x 65cm

For model Sunbed 90:
230cm x 95cm

For model Sofa sunbed:
230cm x 135cm

Pusku pusku Beach Towels are made bigger than the usual bath towels, super absorbent and lightweighted, oversized in order to provide with full comfort while sunbathing on our bean bag or used separately. Our beach towels are made in 3 sizes, which can fit comfortably 1 person as well as the whole family and friends if needed. Compact when folded: ideal for vacations and travels. Our beach towels are made from 100% soft cotton - Terry fabric. This breathable material is totally safe to use and is free of any toxic or allergenic materials OEKO-TEX® 100 certified. It is safe and great for kids. This multipurpose material is breathable, pleasant and soft to touch. Maximum comfort and durability to withstand multiple washing and drying cycles.



// MODEL & FABRIC: SOFA SUNBED CAPRI, SOFTBOX CAPRI, LARGE BEACH TOWEL

COCOON
FAMILY







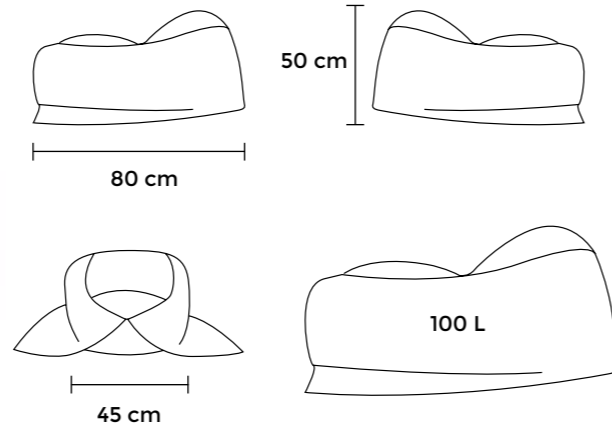

Cocoon 80

Child's best friend!

designed by
balciuno

Pusku pusku Catalogue



-  Length: **80 cm**
-  Height: **50 cm**
-  Width: **45 cm**
-  Volume: **100 L**
-  Handmade
-  With inner bag

The *Cocoon* is a soft multifunctional handmade bean bag for children! The bean bag adapts to every child's body and is extremely comfortable, cosy and cute. The *Cocoon* also has a zipper, which allows its function to be changed. Children can not only sit comfortably on the bean bag, but also use it as a soft blanket. It is not only a little chair, but also a play-bean bag where children can hide. Aside from this, it is a stylish addition to a home's interior design that will help brighten up your children's room. Without any sharp edges, the lightweight *Cocoon* bean bag will become your little one's best friend! Made in Lithuania.

Designed by *balciuno*



// MODEL & FABRIC: COCOON 80 WAVES

Cocoon 100

Cozy and cute bean bag to wrap in!

designed by
balciuno

Pusku pusku Catalogue

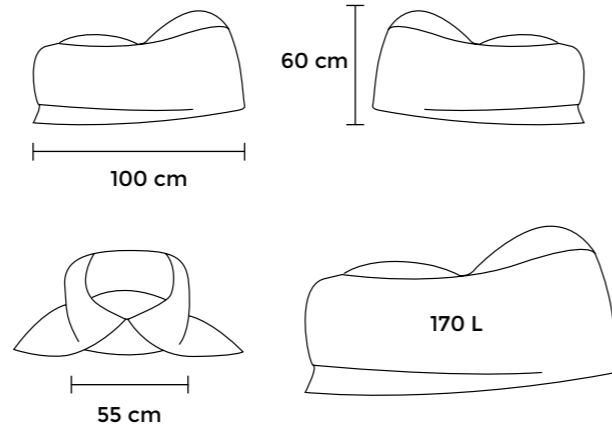

- Length: **100 cm**
- Height: **60 cm**
- Width: **55 cm**
- Volume: **170 L**
- Handmade
- With inner bag

The *Cocoon 100* is a soft multifunctional handmade bean bag for older children and teenagers! The bean bag adapts to body and is extremely comfortable, cozy and cute. The *Cocoon* also has a zipper, which allows its function to be changed. It can be used not only to sit comfortably on, but also use it as a soft blanket and wrap inside of it. Aside from this, it is a stylish addition to a home's interior design that will help brighten up any room. Without any sharp edges, the lightweight *Cocoon* bean bag will become your favorite chill furniture for movie nights, reading days, and chilling moods! Made in Lithuania.

Designed by *balciuno*



// MODEL & FABRIC: COCOON 100 WAVES

Cocoon 120

Favorite bean bag for chilling!

designed by
balciuno

Pusku pusku Catalogue

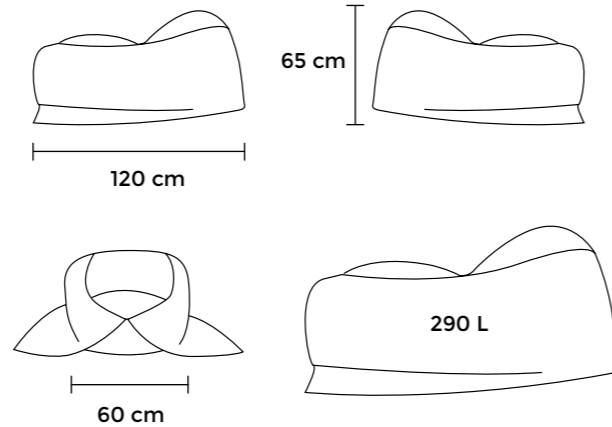

- Length: **120 cm**
- Height: **65 cm**
- Width: **60 cm**
- Volume: **290 L**
- Handmade
- With inner bag

The *Cocoon 120* is another sensational addition to *Cocoon* family that offers an ultimate relaxes for grownups. A soft multifunctional handmade bean bag for teenagers and adults! The *Cocoon* model is created with a zipper and longer edges that serve as blankets and make it so cozy and attractive. It can be used not only to sit comfortably on, but also use it as a soft blanket and wrap inside of it. Aside from this, it is a stylish addition to a home's interior design that will help brighten up any room. Without any sharp edges, the lightweight *Cocoon* bean bag will become your favorite chill furniture for movie nights, reading days, and chilling moods! Made in Lithuania.

Designed by *balciuno*



// MODEL & FABRIC: COCOON 120 WAVES

ZIP FAMILY



SEAT ZIP

For everyone's comfort!
Dimensions: Length: 100 cm,
Height: 85 cm, Width: 80 cm,
Volume: 400 L

ONE SEATER



TWO SEATER



THREE SEATER



LOUNGE ZIP

For a relaxing evening!
Dimensions: Length: 130 cm,
Height: 80 cm, Width: 80 cm,
Volume: 430 L

**ONE
SEATER**



**TWO
SEATER**



**THREE
SEATER**



SUNBED ZIP

For comfortable lying!
Dimensions: Length: 180 cm,
Height: 80 cm, Width: 80 cm,
Volume: 600 L

**ONE
SEATER**



**TWO
SEATER**



**THREE
SEATER**



Razzy

Razzy – For active kids!

Pusku pusku Catalogue

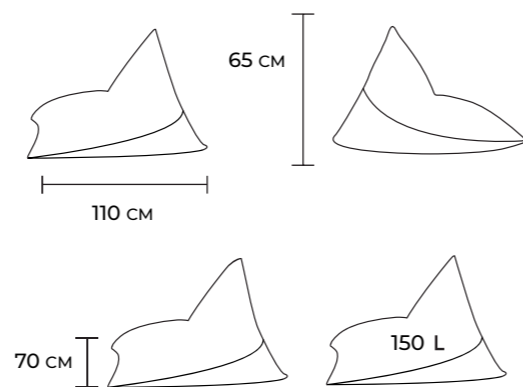

- Length: **110 cm**
- Height: **65 cm**
- Width: **70 cm**
- Volume: **150 L**
- Handmade
- With inner bag

Razzy is a small, triangular bean bag for kids whose rooms don't have much space. A compact piece of furniture designed with a convenient handle so that children playing or cleaning up their rooms can easily carry it elsewhere. *Razzy* is a hand-made bean bag that consists of an outer cover and an inner bag. The bubbles inside conform to the shape of your body. *Razzy* is a practical and comfortable bean bag that is smaller than the *Razz* and *Razzmatazz* bean bags.







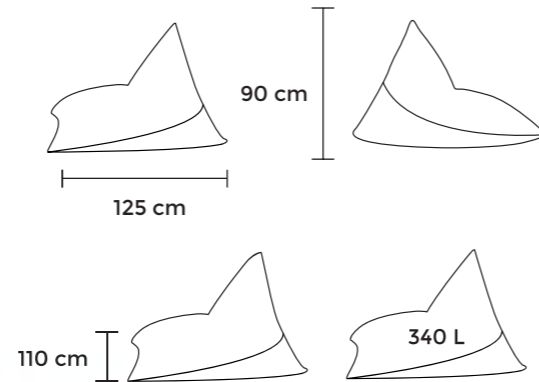

// MODEL & FABRIC: RAZZY QUILTED NORDIC

Razz

For extraordinary comfort!

Pusku pusku Catalogue



-  Length: **125 cm**
-  Height: **90 cm**
-  Width: **110 cm**
-  Volume: **340 L**
-  Handmade
-  With inner bag

Razz is a triangular bean bag designed to feel special comfort. A soft piece of furniture is designed with a backrest; the granules inside it adapt to the body shape, so it is especially suitable for easy lounge. This handmade sitting-bag is equipped with an additional handle inside, so it is convenient to carry it to different places in the room. *Razz* is especially popular among young people, and is often used in the rest rooms of start-ups and during informal meetings.







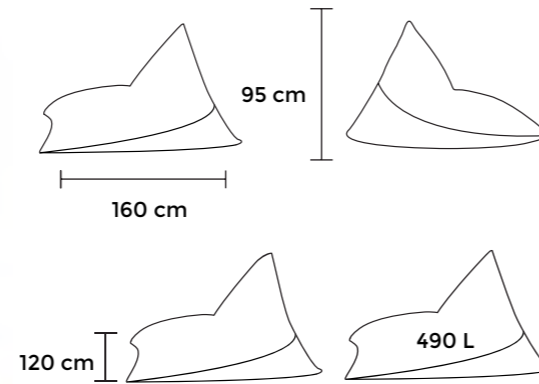

// MODEL & FABRIC: RAZZ WAVES, MINI WAVES

Razzmatazz

For spacious home!

Pusku pusku Catalogue



-  Length: **160 cm**
-  Height: **95 cm**
-  Width: **120 cm**
-  Volume: **490 L**
-  Handmade
-  With inner bag

Razzmatazz is a triangular bean bag for spacious home. A hand-made soft piece of furniture is designed with extended sitting part, a backrest and headrest; the granules adapt to the body shape, so the bean bag is suitable for very tall people. The bean bag is equipped with an additional handle inside, so it is convenient to move it to different places in the room. *Razzmatazz* is a comfortable piece of furniture, often used on outdoor terraces, verandas, cottages or lofts.







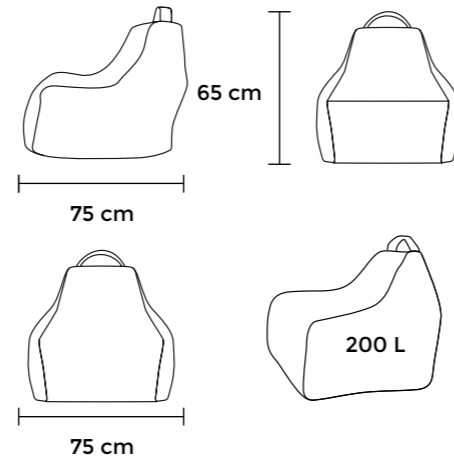

// MODEL & FABRIC: RAZZMATAZZ QUILTED NORDIC

Game

For happy kids!

Pusku pusku Catalogue



-  Length: **75 cm**
-  Height: **65 cm**
-  Width: **75 cm**
-  Volume: **200 L**
-  Handmade
-  With inner bag

Game is a handmade bean bag for children of all ages. This bean bag is equipped with additional handle, which makes it very convenient if you want to move to different gaming sites; it also has an additional pocket, where the little ones can keep their toys. *Game* is a lightweight piece of furniture for children, without sharp corners, so the little ones will avoid injuries; the granules inside it will perfectly adapt to the body shape. This lightweight baby armchair is especially popular when playing table games, drawing or watching movies.







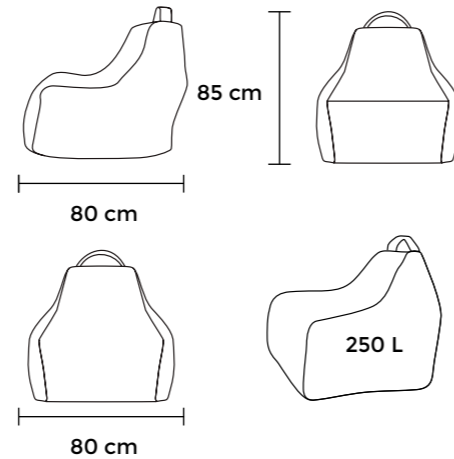

// MODEL & FABRIC: GAME NORDIC

Play

For both, the big and the little ones!

Pusku pusku Catalogue



-  Length: **80 cm**
-  Height: **85 cm**
-  Width: **80 cm**
-  Volume: **250 L**
-  Handmade
-  With inner bag

Play is a handmade bean bag designed for both children and adults. The bean bag of compact size is with an additional handle, which makes it very convenient to move to different places in the room; the granules inside it adapt to the body shape. Soft armchair *Play* is often used as a promotional tool: trademark logos are printed or embroidered on bean bag. The youth organizations as well as the companies that have their recreational areas especially like this lightweight piece of furniture.



/// MODEL & FABRIC: PLAY COLORIN

Roll

For extra soft lounging!

Pusku pusku Catalogue



Roll 85



Roll 100

-  Length: **88 cm / 100 cm**
-  Height: **60 cm / 65 cm**
-  Width: **88 cm / 100 cm**
-  Volume: **300 L / 400 L**
-  Handmade
-  With inner bag

Roll is a donut-shaped bean bag designed for especially soft lounging. Round handmade bean bags are made in two sizes: *Roll 85* is smaller and more compact, and *Roll 100* is more suitable for spacious homes. This soft piece of furniture is designed with handles so that it would be easily moved to different places in the room, thus making it suitable for both children and adults. The granules inside the bean bag perfectly adapt to the body shape, thus providing a person with more comfort. *Roll* is a perfect choice when you just want to lounge and nothing more.







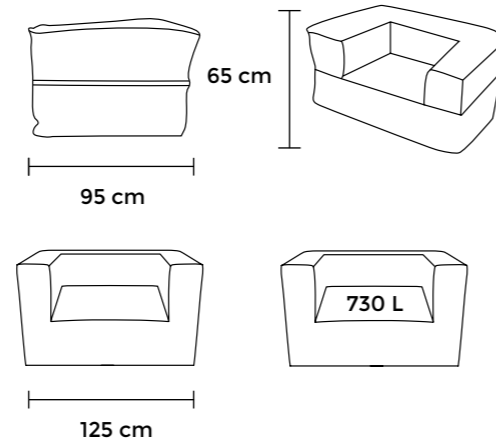

// MODEL & FABRIC: ROLL 100 CAPRI, MINI CAPRI

MooG

For royal rest!

Pusku pusku Catalogue



-  Length: **95 cm**
-  Height: **65 cm**
-  Width: **125 cm**
-  Volume: **730 L**
-  Handmade
-  With inner bag

MooG is a chair-shaped bean bag created for royal rest. At first glance, a handmade bean bag reminds a stable throne, but after sitting, the polystyrene granules inside it adapt to the body shape of a person, and it becomes even more comfortable. Modern and solid-shaped chair is perfect for those, who want to combine classics and modernity in their interior. *MooG* is a bean bag, which creates the impression of a massive piece of furniture, and therefore, it is best for the use in spacious homes or offices.







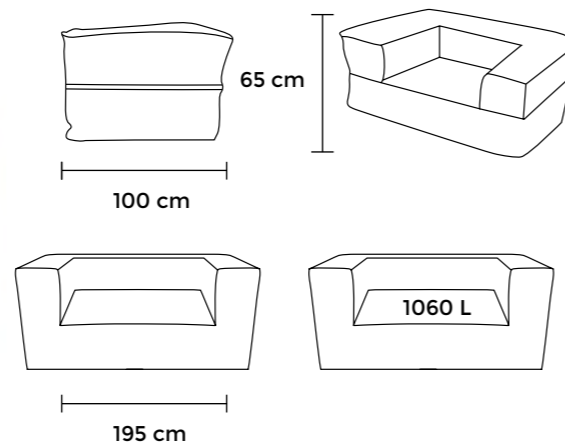

// MODEL & FABRIC: MOOG WAVES, MINI WAVES

Sofa MooG

A royal rest for couples!

Pusku pusku Catalogue



-  Length: **100 cm**
-  Height: **65 cm**
-  Width: **195 cm**
-  Volume: **1060 L**
-  Handmade
-  With inner bag

Sofa MooG is a sofa-shaped bean bag designed for royal relaxation for two. A handmade sofa is the best alternative to conventional sofas, because it goes through any door thanks to polystyrene granules inside it, and most importantly, it adapts to the body shapes of a person. This piece of furniture is suitable for both classical and modern interior; it is commonly used in spacious homes and big offices. *Sofa MooG* is a solid and comfortable bean bag for lovers of non-standard furniture.







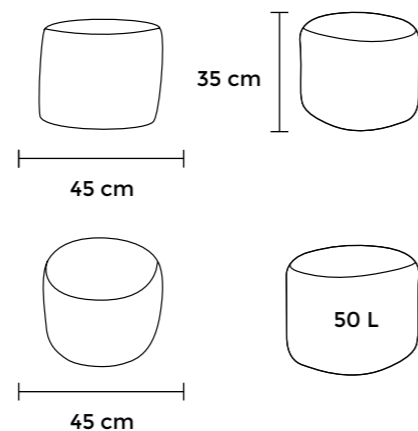

// MODEL & FABRIC: SOFA MOOG BARCELONA

Mini

For unexpected guests!

Pusku pusku Catalogue



-  Length: **45 cm**
-  Height: **35 cm**
-  Width: **45 cm**
-  Volume: **50 L**
-  Handmade
-  With inner bag

Mini is a pouf-shaped compact bean bag designed for both children and adults. Handmade bean bag is suitable for the use in various everyday situations - to seat your unexpected guests or sit down when you put on your shoes, play table games or spend evening at the campfire in the nature. Children especially fancy this light *Mini* bean bag because it is easy to carry, making it a perfect gift for the little ones during various joyful events.







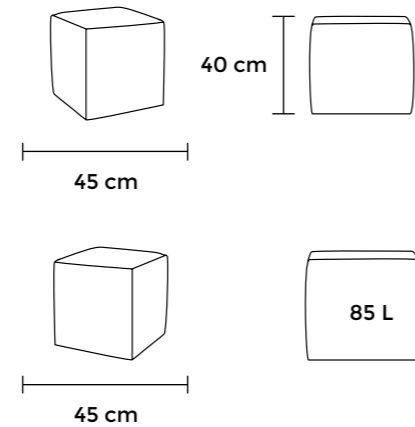

// MODEL & FABRIC: MINI CANARIA

Up!

For kids and guests!



-  Length: **45 cm**
-  Height: **40 cm**
-  Width: **45 cm**
-  Volume: **85 L**
-  Handmade
-  With inner bag

Up! is a cube-shaped bean bag, which is the best alternative to conventional poufs. A handmade bean bag is suitable for both children and adults, because it is very practical: it is of compact size, comfortable and adaptable to body shapes. This pouf is often used to seat unexpected guests or sit down when putting on your shoes. *Up!* is a universal bean bag because it can be used as a table: you can additionally purchase a hard wooden surface, which can be used in the hall, sitting-room or bedroom.



Softbox

For everyday comfort!

Pusku pusku Catalogue

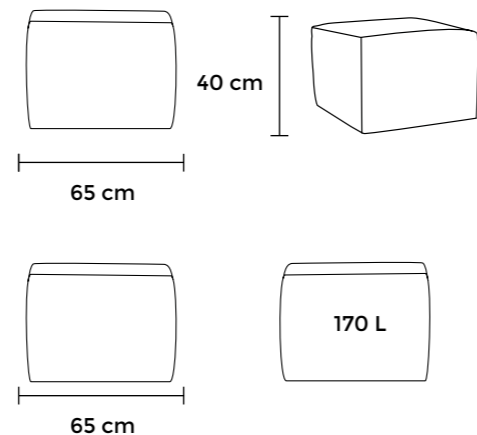

-  Length: **65 cm**
-  Height: **40 cm**
-  Width: **65 cm**
-  Volume: **170 L**
-  Handmade
-  With inner bag

Softbox is a compact, comfortable bean bag designed for pleasant sitting every day. A handmade bean bag is universal, so it can be used as a pouf to sit down, or a table to put your things on it. Children particularly like this bean bag because of its low height and adaptation to body shape, as it is comfortable for them to play or draw. In addition, it is often used to seat unexpected guests, or to sit down when putting on your shoes. *Softbox* is a stylish pouf, which is suitable for both parents and children.







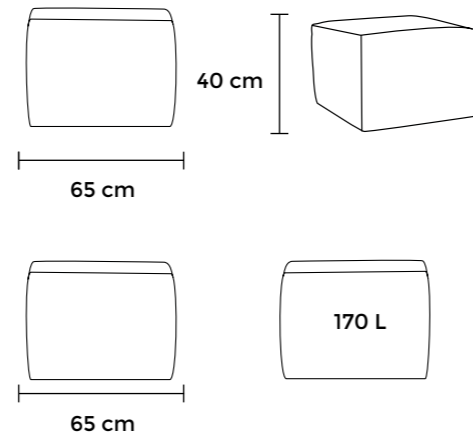

// MODEL & FABRIC: SOFTBOX CAPRI

Soft Table 60

For sitting and setting!

Pusku pusku Catalogue



-  Length: **65 cm**
-  Height: **40 cm**
-  Width: **65 cm**
-  Volume: **170 L**
-  Handmade
-  With inner bag

Soft Table 60 is a set consisting of a handmade bean bag and additional table top, which is designed for sitting and putting things on it. *Top 60* is white-coloured 100% plywood panel framed with natural wood at the edges that are placed on bean bag *Softbox*. This compact size pouf is often used to seat unexpected guests, to sit when putting on your shoes or stretch your tired legs. The set of *Soft Table 60* bean bag and their table top can also additionally be used as a table: to put your laptop, a book or a cup of coffee.







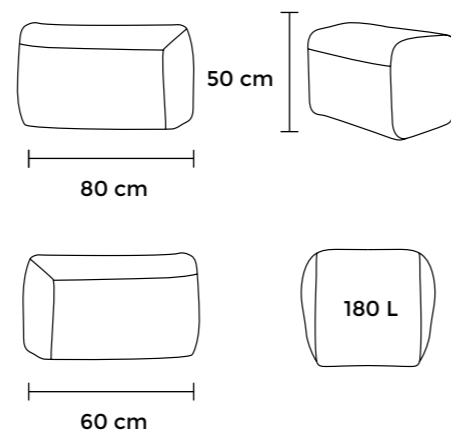

// MODEL & FABRIC: SOFT TABLE 60 CAPRI

Plus

For tired legs!

Pusku pusku Catalogue



-  Length: **80 cm**
-  Height: **50 cm**
-  Width: **60 cm**
-  Volume: **180 L**
-  Handmade
-  With inner bag

Plus is rectangular-shaped bean bag designed to stretch your tired legs conveniently. Handmade pouf is compact in size, and therefore, takes up little space at home; it is easy to move to different places in the room. This pouf is the best combination of comfort and relaxation with Lounge or Seat bean bags. *Plus* bean bag is also often used as a storage space, or seating your unexpected guests.



// MODEL & FABRIC: SEAT, PLUS, MINI WAVES



Fabrics

Our broad assortment of colours and fabrics will let you choose the right *Pusku pusku* bean bag chair for you. Our specialists carefully select fabrics according to technical requirements to ensure the highest quality of the product. Every fabric has its own unique characteristics: some are perfect for relaxing at home while others are indispensable for outdoor use. Choose the option that works best for you!













[More fabrics next page ->](#)



Fabric Capri - the Italian spirit in your terrace!

Capri is a pastel-colored fabric that is suitable for both outdoor and indoor use. Air-permeable, breathable and water-repellent upholstery tapestry is woven of two different colors that give it the touch of summer freshness. A bean bag made of *Capri* fabric is a great choice for those who are looking for stylish outdoor furniture for terraces or balconies. This upholstery tapestry meets the ecological standard OEKO-TEX® 100, so it is completely safe to use, is free of harmful substances and allergens. This high quality, practical upholstery tapestry can be machine washed at 30°C without damaging the fabric.

The main advantages: certified fabric OEKO-TEX® 100, water repellent and suitable for outdoor use, air-permeable, washable

-  Fabric - 100 % olefin
-  Weight: 450 g / m²
-  Abrasion resistant: 56 000 cycles (Martindale test)
-  Machine-washable at a temperature no higher than 30°C
-  Air-permeable
-  Pilling resistance: 4 (based on ISO 12945-2:2002);
-  Water repellent
-  Lightfastness: 8/8 (according to ISO 105-B02 standard)
-  No chemical substances (REACH conformity certification)
-  Certified fabric OEKO-TEX® 100

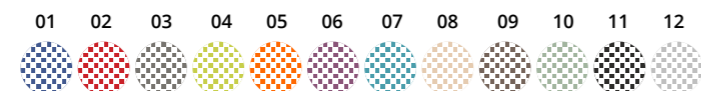

01. Blue, 02. Dark Red, 03. Grey, 04. Lime, 05. Orange, 06. Purple, 07. Turquoise, 08. Beige, 09. Brown, 10. Green, 11. Black, 12. Light Grey



// MODEL & FABRIC: SUNBED CAPRI



Fabric Teddy - luxurious and very fashionable!

Teddy is a super trendy fabric in which any Pusku pusku bean bag model will become a super luxury looking interior detail. Bean bags with *Teddy* has that soft look of sheep faux fur or curly fluffy teddy bear surface due to the way the fibers appear. This beautiful plush fabric is high quality, soft and very pleasant to touch, made of 100 % polyester and can be machine washed whenever needed for a refresh.



100% polyester



Weight: 420 gr/m²



Friction resistance: > 20 000 ISO 12947: 1999 Part 2



Washing at temperatures up to 30°



Breathable fabric



Light resistance: 5 / 8 ISO EN 105-B02;



Contains no chemical substances (verified compliance with REACH)



OEKO-TEX® 100 certified fabric

01

02

03



01. Cream, 02. Camel, 03. Grey











// MODEL & FABRIC: SOFTBOX TEDDY



Fabric Canaria - like a holiday in Spain!

Canaria is a pastel, summer-colored fabric that is suitable for both outdoor or indoor use. Air-permeable, breathable and water-repellent upholstery tapestry is woven from two different colors, the pattern gives the fabric modernity and the touch of summer freshness. Bean bags made of *Canaria* fabric can be taken anywhere – enjoy stylish furniture by the sun in your outdoor terrace, balcony or by the pool! This tapestry meets the ecological standard OEKO-TEX® 100, so it is completely safe to use, is free of harmful substances and allergens. Due to the special composition of tapestry, no mold develops on the fabric. This high quality, practical upholstery can be machine washed at 30°C without damaging the fabric.

-  Fabric - 100 % olefin
-  Weight: 460 g / m²
-  Abrasion resistant: 25 000 cycles (Martindale test)
-  Machine-washable at a temperature no higher than 30°C
-  Breathable fabric
-  Pilling resistance: 5 (based on ISO 12945-2:2002);
-  Water repellent
-  Lightfastness: 8/8 (according to ISO 105-B02 standard)
-  Certified fabric OEKO-TEX® 100

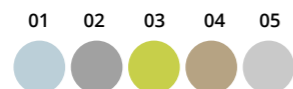

01. Light Blue, 02. Grey, 03. Lime, 04. Sand, 05. Light Grey.













// MODEL & FABRIC: SUNBED CANARIA



Fabric Colorin - a practical choice for the summer!

Colorin is an exquisite tapestry fabric suitable for both outdoor and indoor use. The fabric is water-repellent, breathable and extremely colourfast (> 7/8) – the vivid colours will not fade even in the sunniest of days. OEKO-TEX® Class1 certificate ensures that the fabric is free of any toxic substances and allergens, making it a perfect choice for both adults and children. Bean bags made of *Colorin* can be taken anywhere – enjoy the sun in your outdoor terrace, balcony or by the pool!

Key features: manufactured in Spain, suitable for both indoor and outdoor use, machine-washable, water-repellent, suitable for children, extremely high colourfastness, high-quality, breathable fabric.

-  Fabric – 100% Olefin + Teflon water-repellent layer
-  Weight: 250 g / m²
-  Abrasion resistant: 20 000 cycles (Martindale test)
-  Machine-washable at a temperature no higher than 40°C
-  Water-repellent
-  Colour fastness to chlorinated Water: 5/5 (ISO 105-E03)
-  Colour fastness to abrasion: 4/5 (ISO 105-X12)
-  Lightfastness: 7/8 (according to ISO 105-B02 standard)
-  Pilling resistance: 5 (based on ISO 12945-2:2002);
-  Certified fabric OEKO-TEX® 100

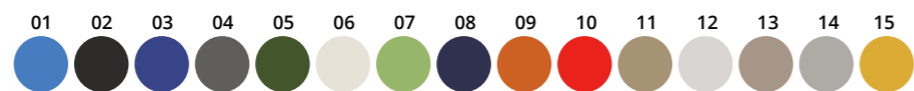

01. Azure, 02. Black, 03. Blue, 04. Dark Grey, 05. Green, 06. Ivory, 07. Lime, 08. Navy, 09. Orange, 10. Red, 11. Sand, 12. Silver, 13. Taupe, 14. White Grey, 15. Yellow.





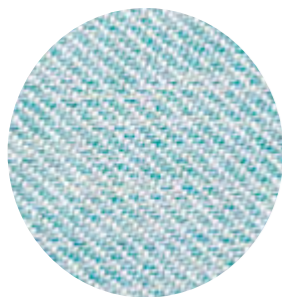







// MODEL & FABRIC: SEAT COLORIN, SOFTBOX COLORIN



Fabric Riviera – for temporary outdoor use!

Riviera is the material that comes in a variety of pastel colours, which is suitable for use both in indoor and outdoor spaces. The fabric surface is provided with a special coating – the stain-free layer (teflon) offering lasting protection against dirt and moisture and ensuring run-off of spilled fluids (preventing absorption).

Riviera is child-friendly as it contains no chemical substances (REACH conformity certification) and easy-care – the top surface impurities can be easily wiped off and the external case is suitable for machine wash at 40°C. This is a breathable fabric, which is suitable for temporary outdoor use: on porches, terraces, beaches and pool areas. *Riviera* fabric – a practical choice inspired by the Mediterranean Sea!

-  Fabric – 100 % stain-free polyester
-  Weight: 320 g / m²
-  Abrasion resistant: 100 000 cycles (Martindale test)
-  Machine-washable at a temperature no higher than 40°C, dry cleaning possible
-  Breathable fabric
-  Active stain-free protection (provided with special coating – Repellan®)
-  Hydrophobic fabric (water drops on the fabric surface will run off as separate beads)
-  Lightfastness: 6/8 (according to ISO 105-B02 standard)
-  No chemical substances (REACH conformity certification)
-  Certified fabric OEKO-TEX® 100



01. Aquamarine, 02. Flamingo Pink, 03. Light Grey, 04. Cacao.





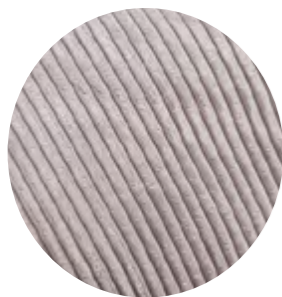





// MODEL & FABRIC: RAZZ RIVIERA, TUBE RIVIERA



Fabric Waves - wide wale corduroy!

Waves - a cord velvet that is exceptionally smooth to the touch. The surface of this fabric consists of evenly distributed cut threads with a short dense pile that make the fabric remarkably soft. This wide-waled corduroy was made without using chemical additives (verified compliance with REACH) and is suitable for interior use. The bean bags made out of this soft, breathable fabric *Waves* fill the room with coziness and looks unique! When necessary, the velvet cord cover should be washed at no more than 30 degrees Celsius.

Main advantages: breathable upholstery fabric, thick and smooth wide wale corduroy, no chemical additives used, washing machine friendly!

-  Fabric - 100% polyester
-  Weight: 380 g / m²
-  Abrasion resistant: 100 000 cycles (Martindale test)
-  Machine-washable at a temperature no higher than 30°C
-  Breathable fabric
-  Pilling resistance: 4 (based on ISO 12945-2:2002);
-  Colour fastness to light: 4-5 / 8 (based on ISO 105 B02)
-  No chemical substances (REACH conformity certification)

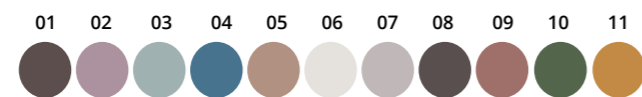

01. Chocolate, 02. Lilac, 03. Mint, 04. Petrol, 05. Sand, 06. Snow, 07. White Grey, 08. Dark Grey, 09. Coral, 10. Green, 11. Mustard.











// MODEL & FABRIC: TUBE, MINI WAVES



Fabric Lure Floral - charming and stylish velour

Lure Floral is a velour, floral-stitched fabric that looks extremely stylish and luxurious in different interiors. This fabric has an extra sewn-in padded layer on the inside, which makes the bean bag hold its shape more firmly. No chemicals are used in the production of this *Lure Floral* slightly shimmering fabric (verified compliance with REACH) and it is suitable for indoor use. This breathable upholstery tapestry is soft and pleasant to the touch, giving the impression of coziness. The stains on the outside of the beanbags made from *Lure Floral* fabric can be cleaned by dry cleaning or by hand washing.

-  Fabric - 100% polyester
-  Weight: 615 g / m²
-  Abrasion resistant: >100 000 cycles (Martindale test)
-  Machine-washable at a temperature no higher than 30°C, dry cleaning recommended
-  Breathable fabric
-  Pilling resistance: 5 (based on ISO 12945-2:2002);
-  Lightfastness: 4/8 (according to ISO 105-B02 standard)
-  No chemical substances (REACH conformity certification)
-  Certified fabric OEKO-TEX® 100



01. Light Grey, 02. Pastel Blue, 03. Purple, 04. Turquoise.



// MODEL & FABRIC: SOFA TUBE, SOFTBOX LURE FLORAL

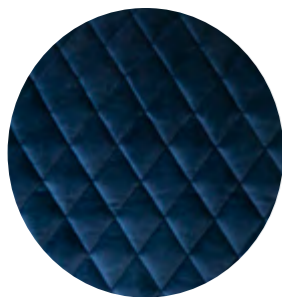

Fabric Lure Luxe - charming and stylish velour

Lure Luxe is a velour, diamond-quilted fabric that looks extremely stylish in different interiors. This fabric has an extra sewn-in padded layer on the inside, which makes the bean bag hold its shape more firmly. No chemicals are used in the production of this *Lure Luxe* slightly shimmering fabric (verified compliance with REACH) and it is suitable for interior use. This breathable upholstery tapestry is soft and pleasant to the touch, which gives it extra cosiness. The stains on the outside of the beanbags made from *Lure Luxe* fabric can be cleaned by dry cleaning or by hand washing.

Key advantages: firm fabric, padded layer on the inside, which makes the bean bag hold its shape more firmly, OEKO-TEX® 100 certified fabric, diamond-quilted fabric, fabric is in compliance with REACH, no chemicals.



Fabric - 100% polyester



Weight: 615 g / m²



Abrasion resistant: >100 000 cycles (Martindale test)



Machine-washable at a temperature no higher than 30°C, dry cleaning recommended



Breathable fabric



Pilling resistance: 5 (based on ISO 12945-2:2002);



Lightfastness: 4/8 (according to ISO 105-B02 standard)



No chemical substances (REACH conformity certification)



Certified fabric OEKO-TEX® 100

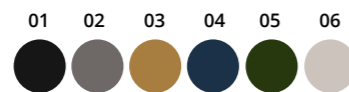

01. Black, 02. Grey, 03. Mustard, 04. Navy, 05 Green, 06 Pearl.











// MODEL & FABRIC: SOFA SEAT LURE LUXE



Fabric Barcelona – modern and luxurious!

Barcelona is a velvet fabric that looks luxurious and modern in different interiors. This furniture fabric is breathable and features a special layer that prevents the rapid absorption of liquids. *Barcelona's* short-pile surface is soft, meaning that not only will bean bags with this fabric be comfortable, they will also be pleasant to touch. No chemicals are used in the production of this slightly shimmering fabric (verified compliance with REACH) and it is suitable for interior use. If needed, we recommend dry-cleaning the bean bag's cover using tetrachloroethylene. Give your home a touch of luxury with *Barcelona* fabric bean bags!

-  Fabric made of 100% polyester
-  Weight: 440 g/m²
-  Abrasion resistance: >100000 (Martindale test)
-  Light resistance: 5 (according to DIN EN ISO 105-B02)
-  Pilling resistance: 5 (according to DIN EN ISO 12945-2)
-  Breathable
-  Dry cleaning with tetrachlorethylene
-  No chemical substances (REACH conformity certification)

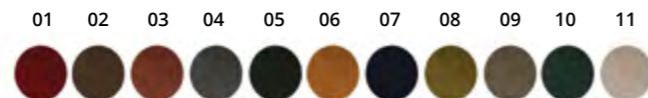

01. Bordo, 02. Brownie, 03. Coral, 04. Dark Grey, 05. Green, 06. Mustard, 07. Navy, 08. Olive, 09. Taupe, 10. Dark Turquoise, 11. White Grey.



// MODEL & FABRIC: MOOG BARCELONA, SOFA MOOG BARCELONA



Fabric Masterful - luxurious and high quality!

Masterful - the highest quality faux suede fabric, with its excellent properties offers a range of benefits over opting for real leather. This animal-friendly alternative maintains the appearance and texture of suede down to the soft, brushed surface without the disadvantage of fraying or potential matting. Bean bags made of this fabric looks extremely modern, solid, stylish and luxurious in the interior. This fabric is fire-resistant, breathable and features a special wax layer that prevents the rapid absorption of liquids. *Masterful* is made without chemicals and has an ecological certificate "OEKO-TEX 100", so it is also suitable for children. If necessary, it is recommended to wash the bean bag cover by hand.



Fabric made of 100% polyester



Weight: 550 g/m²



Abrasion resistance: 45 000 (EN ISO 12947-1)



Light resistance: 5 5 (4-5 pagal EN ISO 105-B02)



Hand washing at temperatures up to 30°, dry cleaning recommended



No chemical substances (REACH conformity certification)



Certified fabric OEKO-TEX® 100

01 02 03



01. Grey, 02. Taupe, 03. White Grey.



// MODEL & FABRIC: LOUNGE, MINI MASTERFUL

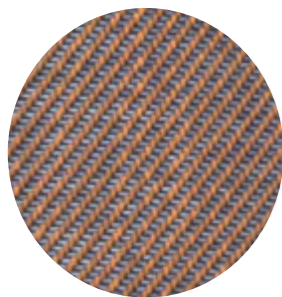

Fabric Sideway – inspired by nature!

Sideway is a fabric woven in a non-traditional way in line with the most recent trends, which is why the material looks as if composed of several different shades. *Sideway* contains natural materials (cotton, flax), so the textile feels and looks pleasantly natural. The bean bags sewn from this material are for indoor use. It is a breathable material that has the OEKO-TEX® 100 certificate which confirms that this furniture tapestry meets the OEKO-TEX® international environmental standard. This means that the high-quality and dependable *Sideway* fabric is totally safe to use and is free of any toxic or allergenic materials. That's why it's great for kids.



25% cotton; 25% polyester; 25% polypropylene; 21% viscose; 4% flax



Weight: 432 g/m²



Light colour fastness: : 5/8 (according to the LST ISO 105-B02 and LST ISO 105-A01 standart)



Certified fabric OEKO-TEX® 100



Abrasion resistance: 25 000 (Martindale test)



Breathable



Dry cleaning with tetrachlorethylene



No chemical substances (REACH conformity certification)



01. Grey, 02. Bronze, 03. Silver.





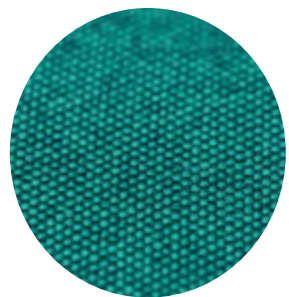



// MODEL & FABRIC: SOFA SEAT, SEAT, MINI SIDEWAY



Fabric Nordic – stylish and Scandinavian!

Nordic is an especially soft fabric for indoor use and very pleasant to touch. There is a wide variety of choice in *Nordic* pallet, so you can find both pastel and vivid colours. Combining these Scandinavian shades and fabric softness you can find the perfect solution for you home interior!

Our fabric *Nordic* has received a OEKO-TEX® 100 certificate. *Nordic* fabric has a OEKO-TEX® 100 certificate that confirms that this furniture tapestry meets the international ecological standard OEKO-TEX®. This means that the *Nordic* material is high quality, completely safe to use, reliable, and contains no harmful substances and allergens, therefore it is particularly suitable for children.

-  100 % polyester
-  Weight: 330 g/ m²
-  Abrasion resistance: 100 000 cycles (Martindale test)
-  Washable
-  Breathable
100 % Poliesteris, padengtas PVC danga
-  Certified fabric OEKO-TEX® 100

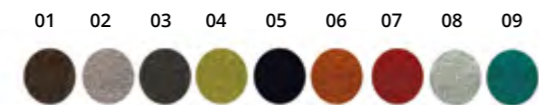







01. Chocolate, 02. Concrete, 03. Grey, 04. Lime, 05. Navy, 6. Pumpkin 07. Red, 08. Silver, 9. Turquoise.



Fabric Murr - soft and fluffy faux fur!

Stylish and smooth to the touch - *Murr* faux fur compliments a wide variety of interior designs. Its playful elegance hints at the luxurious, but its soft demeanour promises cosiness and comfort. In a sentence: it's made for those who just want to snuggle up on a cold winter's night. Short-pile and dense, *Murr* faux fur is produced entirely without chemicals (REACH-compliant). Bean bags made out of *Murr* contain no harmful substances or allergens, making them especially suitable for children. Covers can be dry cleaned if necessary.

-  100 % polyester
-  Weight: 728 g/ m²
-  Abrasion resistance: >20 000 (Martindale test, DIN EN ISO 12947-1,2)
-  Light resistance: (based on DIN EN ISO 05 B02)
-  Dry cleaning
-  Breathable
-  No chemical substances (REACH conformity certification)



01. Grey

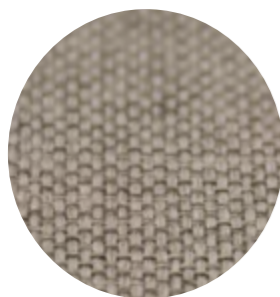

Fabric Home – cozy and subtle!

Home is a cozy fabric for a cozy and calm room where silence and stillness allows you to relax completely. It's suitable for mature people who are looking for furniture in pastel colors. It has an option of plain colors that can be combined together in the best way for your interior design. Don't worry if it gets dirty, you can simply take the outer bag off and wash it in a washing machine.

Our fabric *Home* has received an OEKO-TEX® 100 certificate. *Home* fabric has an OEKO-TEX® 100 certificate that confirms that this furniture tapestry meets the international ecological standard OEKO-TEX®. This means that the *Home* material is high quality, completely safe to use, reliable, and contains no harmful substances and allergens, therefore it is particularly suitable for children.



100 % polyester



Weight: 305 g/ m²



Abrasion resistance: 100 000 cycles (Martindale test)



Washable



Breathable



Certified fabric OEKO-TEX® 100



01. Cacao, 02. Light Grey, 03. Dark Grey, 04. Dark Cinnamon.



// MODEL & FABRIC: SEAT HOME

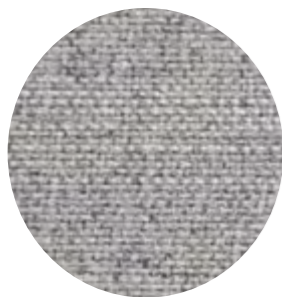

Fabric Gaia - recycled from used PET bottles

We are so excited to introduce with our most recent and first recycled fabric *Gaia*. It is made from post customer use recycled plastic.

It is one more strong step forward towards sustainable consumption and cleaner world. All of us can give plastic bottles a second life and enjoy fabric made of recycled materials. With our sights set for intelligent solutions, we proudly present the new *Gaia* collection. The fibers used to produce this fabric are made of recyclable polyester waste, which is confirmed by the GRS (Global Recycled Standard) certification.

This fabric comes with an amazing concept and also is very soft to touch, comes in pastel colors and looks beautiful in modern and classic interior. Fabric is also easy to look after, can be washed in washing machine (not higher than 30° C).



Fabric - 100% PES, Post-Consumer Recycled Polyester



Weight: 370 g / m²



Abrasion resistant: 67 000 cycles (Martindale test)



Machine-washable at a temperature no higher than 30°C



Breathable fabric



Fire resistant DIN EN 1021-1 (cigarette test)



Light resistance: 5/6 (based on SO 105 B02:2014-11)



Pilling resistance: 5 (based on ISO 12945-2:2002);



Certified fabric OEKO-TEX® 100



No chemical substances (REACH conformity certification)



01. White Grey, 02. Mint, 03. Coral, 04. Grey.













// MODEL & FABRIC: SOFA TUBE GAIA, PILLOW SQUARE 65 GAIA



Fabric Outside – inside and outside!

Outside is a strong and durable artificial leather suitable for use both outdoors and indoors! *Outside* is a very practical material: it is easy to maintain, because any dust or dirt can be easily cleaned with a wet cloth. You can print extra-bright colours and high-quality images on the *Outside* fabric; therefore, it is highly recommended for companies wishing to advertise their brands. Use the beanbag chairs made of this fabric anywhere and anytime!

-  Artificial leather (2% PU, 83% PVC, 15% polyester)
-  Non-flammable (according to the EN1021 1+2 standard)
-  Cleanable
-  Water resistant
-  Fabric weight: 600 g / m²
-  Abrasion resistance: 120,000 cycles (Martindale test)
-  Lightfastness: 7/8 (according to the ISO 105-B02 standard)
-  Does not pose a hazard to human health (according to the Health Quality certificate)
-  No chemical substances (REACH conformity certification)
-  There are no harmful dyes (according to an Ecological test), including printed Outside fabric
-  Meets the hygiene standards (according to the Hygiene certificate)





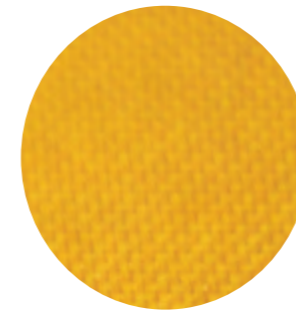



01. White, 02. Beige, 03. Orange, 04. Yellow, 05. Dark Blue, 06. Green, 07. Red, 08. Black, 09. Blue, 10. Brown, 11. Dark Red, 12. Grey.



Fabric OX – youthful and flamboyant!

OX is a very bright and colorful fabric, especially suitable for youngsters. Actually, it is our most popular fabric. Why? We think that everyone wants to be young and have some piece of “Youthful Flamboyance!”. Advertising companies love this fabric, because it is waterproof and they can place it in indoor/outdoor events. *OX* is perfect for public, because it is suitable for hard use. The fabric is practical, because it can be cleaned or washed easily.

-  100 % polyester with PVC backing
-  Weight: 380 g / m²
-  Abrasion resistance: 60 000 cycles (Martindale test)
-  For temporary use outside
-  Washable
-  Cleanable

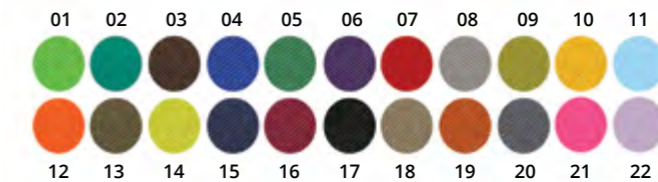

01. Fresh, 02. Turquoise, 03. Chocolate, 04. Blue, 05. Green, 06. Purple, 07. Red, 08. White Grey, 09. Lime, 10. Yellow, 11. Light Blue, 12. Orange, 13. Khaki, 14. Kiwi, 15. Navy, 16. Burgundy, 17. Black, 18. Beige, 19. Pumpkin, 20. Grey, 21. Pink, 22. Lilac.

EVERYTHING ABOUT QUALITY

MAIN INFORMATION



Inside and outside

We are making *Pusku pusku* bean bags with love! Product quality control is observed in the process of manufacturing of bean bags, which is ensured by assigning a quality code in every phase of manufacturing.

All bean bags consist of two bags:

- **an inside bag**, which is filled with a bean bag filling, i. e. polystyrene (EPS) beads;
- **an outside bag**, which is easy to take off and wash or clean (depending on the kind of textile it is made of).

Only strong cloths of special selection and tested by means of the Martindale textile resistance test are used for manufacturing our bean bags.

Zippers

Strong zippers with wide teeth are used for outside bags. Pulls of zippers are hidden under the seam of the cloth thus ensuring protection of the floor covering from damage. All inside bags have zippers, which enables the manufacturer to regulate the quantity of the filling that determines softness of the bean bag.

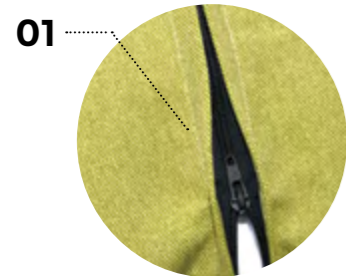

01

// OUTSIDE ZIPPER



02

// INSIDE ZIPPER

Bean bag Beads

Polystyrene beads that are used for the filling are getting naturally compressed by seating in the course of time. Higher durability and higher density granules are used for *Pusku pusku* bean bags. With the aim to prevent the fire risk, non-flammable granules that are certified as conforming DIN 4102 standard are used for bean bags.



Packaging

Bean bags are **packed in two ways** on the request of the client:

- in two thick and strong bags made of recycled polyethylene or
- in a cardboard box containing a pre-packed product in a protective polyethylene bag.
- To control the package's moisture levels, every bean bag comes with a disposable baggie that absorbs moisture – a desiccant bag.



Bean bag MINI packaging example

Bean bag threads and details

Elements for bean bags are cut out semi-automatically. This method enables the manufacturer to avoid any divergence from the set measurements and eliminate defects in the final product. Edges of all textile elements (cut-outs) used for the manufacturing of bean bags are thread-hemmed thus preventing the cloth from raveling and ensuring high quality of the product. Bean bags are sewn by making a double-stitched seam with reinforced (enhanced strength) threads.



Soft woven labels are used for labelling bean bags.

Advertising

Every year, many companies attempt to find ways to increase popularity of their trademark and attract potential customers. How to become more visible? How to ensure visibility at various events, festivals, beaches and in other public places? Which advertising means must be used to ensure your trademark's long-term benefits?

Jim Beam, Bolt, Coca-Cola, Paulig, Malibu, Chupa Chups, Carlsberg, Palmolive, Beach Tennis Club, Somersby, Lays, Pepsi, DPD, Google, Bacardi, Perrier, KIA, Pringles – all these brands have already invoked one particular advertising measure – bean bags with logo prints or embroidery. The high quality *Pusku pusku* bean bags can be successfully integrated into the advertising campaigns (e.g., “buy a product – win a bean bag”); presentations or tasting demonstrations; recreational areas at various events where the consumers happily lounge on bean bags and share their pleasant moments on Facebook and Instagram all year long!



PLAY / MINI BEAN BAGS EMBROIDERY



COCA-COLA POP-UP STORE

Print

Pusku pusku handcrafted bean bags can be designed according to your request. You can choose partial printing or completely cover the bean bag chair with your chosen image. For the best result, we recommend the OX or Outside fabrics.



PRINT Examples



PRINT DESIGN NO.1



PAULIG COFFEE DEGUSTATION



PRINT DESIGN NO.2

// MODEL & FABRIC: SEAT OUTSIDE

Embroidery

Because of our broad assortment of bean bags, both children and adults can find the right option for them, and all of our bean bag chairs can be embroidered according to your choice. We embroider logos, names or other messages on various fabrics and at various sizes. Contact us and we'll make a unique bean bag just for you!



EMBROIDERY Examples

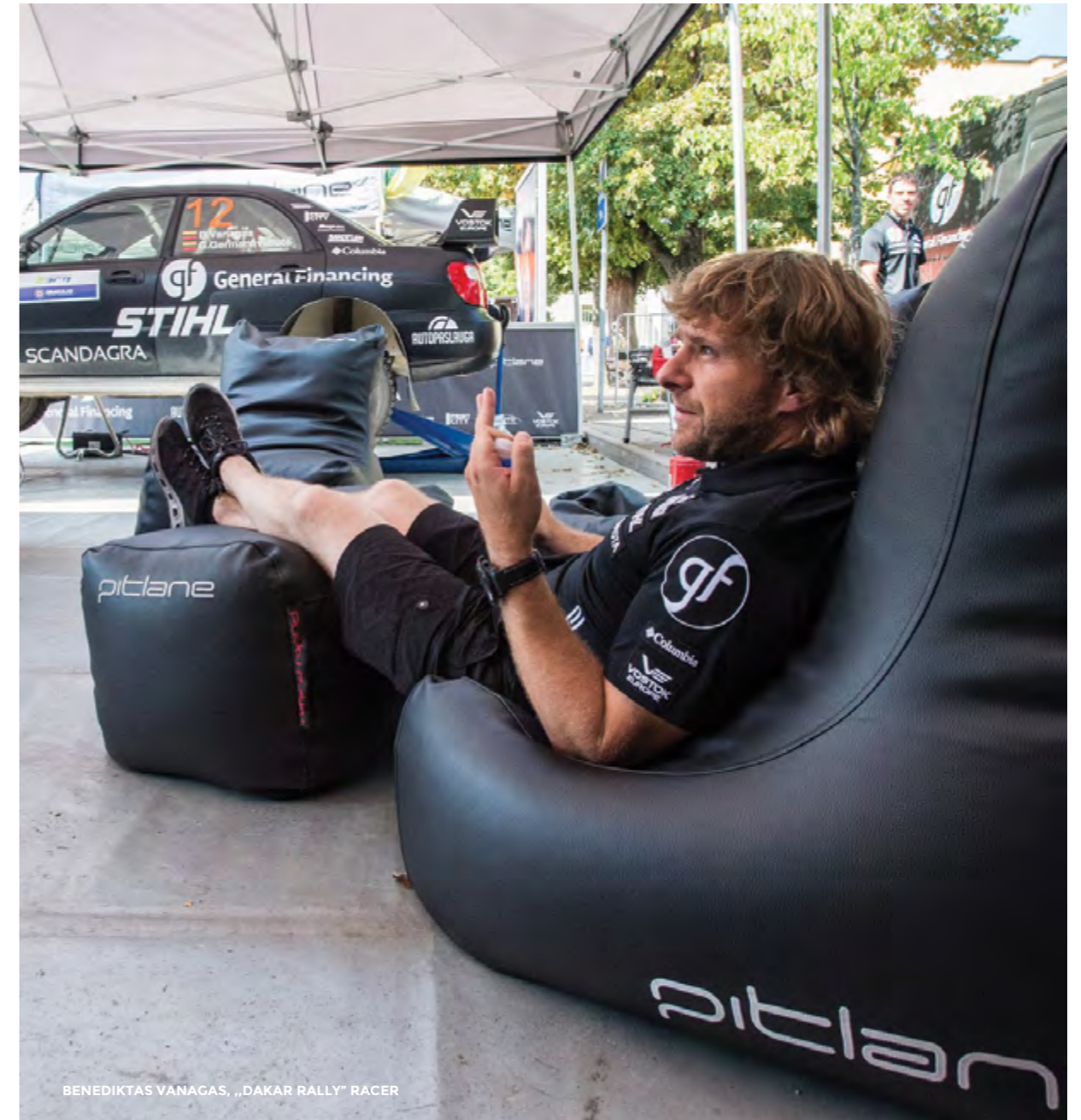

BENEDIKTAS VANAGAS, „DAKAR RALLY“ RACER

// MODEL & FABRIC: SEAT / PLUS OUTSIDE, EMBROIDERY

Contacts

Global:

www.puskupusku.com

email: sales@puskupusku.com

phone: +370 685 50921

Germany:

www.puskupusku.de

email: info@puskupusku.de

phone: +49 800 0009760

Lithuania:

www.puskupusku.it

email: noriu@puskupusku.lt

phone: +370 620 95094

Italy:

www.puskupusku.it

email: info@puskupusku.it

phone: +39 3534 046031

Production and delivery terms in Europe

Production terms:

Standard bean bags (small amount of products, till 10) 2-4 working days

Standard bean bags (more than 10 units) 5-10 working days

Printed bean bags 15 - 20 working days

Bean bags Embroidery 15 - 20 working days

Delivery terms:

5 - 7 working days in Europe



PUŠKU PUŠKU

The biggest bean bag manufacturer in Northern Europe



HANDMADE BEAN BAGS

since
2008

MADE WITH LOVE IN LITHUANIA

